

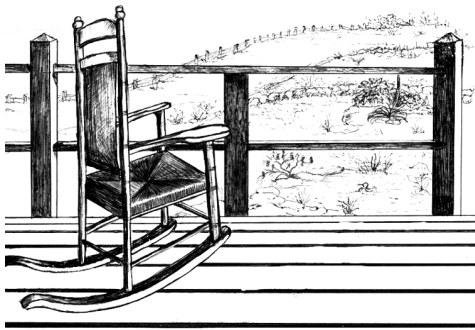

# TIMBER DECKING

# 1



**Before purchasing tools, timber and materials, read every step thoroughly then talk to one of our experts**

Few home improvements can match a wood deck for usefulness, beauty and enhanced value to a home. For adults, decks offer outdoor living space for entertaining, sun bathing and dining. For children, they provide an excellent outdoor play area.

## Step 1: Before You Start

Regardless of the type of deck you plan to build, be sure you know the locations of any underground utilities and check any local regulations applying to decks before beginning construction.

## Step 2: Choosing Materials

Decks consist of six parts: footings, posts, bearers, joists, decking and railing. You will need to use span tables to determine the timber sizes you require for the type of timber you are going to be using. The majority of decks are made using treated pine. Treated pine timber should have an H4 rating for on, or below ground application and an H3 rating for above ground.

This timber is treated with compounds of copper, chromium and arsenic, termed CCA. When using this material:

- Wear gloves and dust masks when sawing.
- Any cut or sawn surface of this material will need resealing to ensure its effectiveness in resisting attack.
- Dispose of any off cuts by burying them. Don't burn them as the smoke and ash are toxic.

Nails should be hot-dipped galvanised to ensure maximum resistance to corrosion and also to reduce marking of the timber from rust stains. Bolts, nuts, washers, coach screws or any other fixing device should also be hot-dipped galvanised to maximise the longevity of the deck.

## Step 3: Locating Posts

Using pegs and a string line, lay out the location of each post (Fig. 2). Space posts according to span tables in either direction.

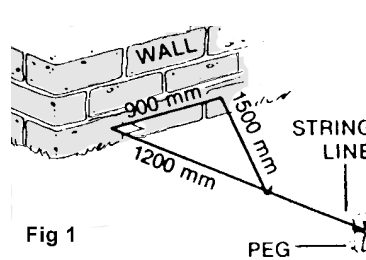

Fig 1

Check that the string grid is square by using the 3 - 4 - 5 rule (Fig. 1). The angle is 90 degrees if the distance across the hypotenuse of this triangle is 1500mm. Mark the position of each post.

Remove the string line. (Do not remove the string line pegs).

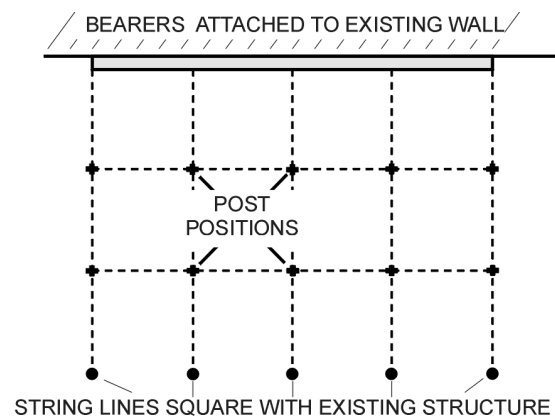

Fig. 2

## Step 4: Setting Foundations

Dig 300mm x 300mm x 300mm foundation holes centred on the post location, (Fig. 3). Mix concrete and pour foundation. While concrete is still wet reset string lines, position galvanised post supports at each post location.

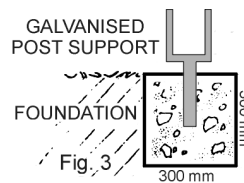

Fig. 3

Shoes should clear ground level by 75mm and must be square with string lines.

Where decks are attached to existing buildings, it is not necessary to place posts next to wall (Fig. 4).

## Step 5: Cutting Posts To Height

When a deck is attached to the side of a house, one end of the deck joists is supported by a level, pressure-treated, ledger board bolted to the house frame or foundation (Fig. 4).

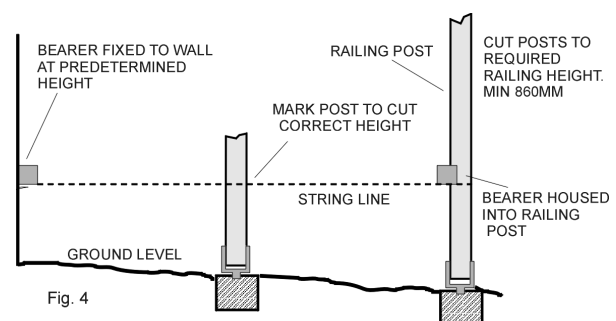

Fig. 4

The ledger is usually the same size and material as the deck joists, and is attached to the house so that the top of the finished decking is 25mm to 50mm below the interior floor level. This helps to keep rain and debris out of the house. Flashing protects the ledger and keeps water away from the side of the house.

Place posts temporarily into supports (ensure that posts seat firmly to the base of the post support). Using 10mm galvanised bolts and washers, attach posts to supports. Using a string line and level, mark the bearer height on all posts (Fig. 4). Check that all levels are correct, number posts in sequence, remove posts and cut to height.

When a railing is to be assembled using posts, house the bearer into the railing post as in Figs. 4 and 5.

Reposition posts (in sequence), check height, bolt posts to supports. Where necessary temporarily brace posts in vertical position.

## Step 6: Bearers and Joists

Bolt bearers to railing posts using 10mm galvanised bolts. Attach bearers to other posts by skew nailing. Where a beam must be joined, all joints must be positioned over posts (Fig. 6)

**NOTE:** Bearers run parallel to the direction of decking boards, joists run at right angles to bearers and decking boards. (Fig. 6)

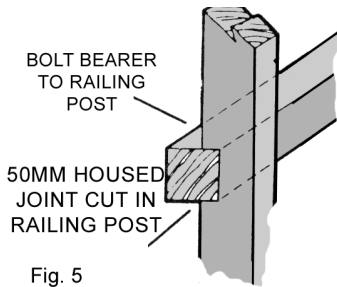

Fig. 5

Skew nail (or use nail plates) joists at right angles to each bearer. Space joists according to span tables. Use heavy gauge galvanised nails, if necessary, drill joists to prevent splitting.

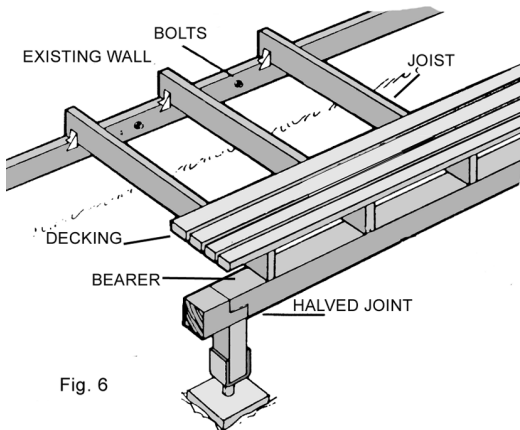

Fig. 6

## Step 7: Positioning Cross Braces

Diagonal cross braces are required on all decks exceeding 1200mm in height. Cross braces are bolted to all posts. Alternate direction of braces with each row of posts. Neither cross braces or posts should be in contact with the ground.

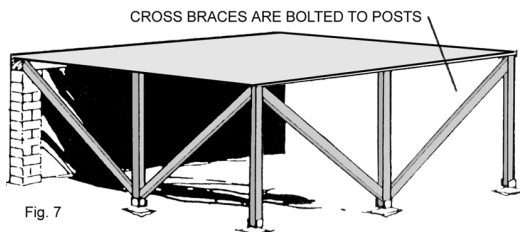

Fig. 7

## Step 8: Attaching Decking

Ideally you should buy decking boards that are long enough to span the width of the deck. If boards must be butted end-to-end, make sure to stagger the joints so they do not overlap from row to row. Pre-drill the ends of

boards to prevent screws or nails from splitting the wood.

Position the first row of decking 3mm from the house. First decking board should be perfectly straight, and should be pre-cut to proper length.

Position remaining decking boards (spaced about 3mm apart) so that ends overhang outside joists.

You can lay out deck boards in interesting patterns ... but if you choose to do this, you will need more interconnecting joists.

Notch the boards around posts or other obstructions, leaving 3mm space for drainage. Use two fasteners per support point and drill 3mm pilot holes about 25mm from ends of boards to prevent nails or screws from splitting timber.

If boards are bowed, use a pry bar to lever them into position while fastening.

After every few rows of decking are installed, measure from edge of the decking board to edge of header joist. If measurements show that the last board will not fit flush against the edge of the deck, adjust board spacing by changing the gaps between boards by a small amount over three or four rows of boards. Very small spacing changes will not be obvious to the eye.

Once the decking boards are attached, use a string to form a straight line along the edges of the deck and saw them all off in one go. You could allow the decking boards to overlap about 40mm over the frame or cut them flush and fit deck boards to the side joists as a fascia and to hide the ends of the joists.

When cutting the lengths of wood, always seal the ends with a sealant to prevent water penetrating the deck.

## Decking Hints

- Make sure that your project conforms to your local government regulations and that necessary approval is received.
- Make sure post holes are not going to interfere with any utilities, such as electricity, water and communications.
- For low level decks, cover ground surface with plastic, bark or gravel to prevent weed growth.
- Paint or stain all bearers and joists and the decking boards prior to assembly. We can help you select the right finish for the job.

**Important Notice:** After the end of March 2006, CCA treated timber will not be permitted for use as handrails, decking boards, picnic tables and children's playground equipment. These products will need to be treated with an alternative timber treatment such as ACQ (alkaline copper quaternary)

### Disclaimer:

*The Retailer which supplies this information (which includes the authors of this advice and the owner, proprietors and employees) is not responsible for the results of any actions taken on the basis of this information nor for any error or omission in this advice. The Retailer expressly disclaims all and any liability and responsibility in respect of anything done consequent on the whole or any part of this advice.*

*The recipient of this advice is advised to call a qualified tradesperson such as an electrician, plumber or carpenter where expert services are required.*

*Building permits may be required and there may be legal requirements or statutory bodies that need to be followed in the implementation of this advice. All such permits and requirements are the responsibility of the recipient of this advice.*

© Copyright Hardware & Building Traders Pty Limited

## With Compliments